

HJ1004BPK25 -- Cord Connectors



Hubbell Juniors are a miniature liquidtight version of the full-sized Hubbell cord connectors. They feature the same GOTCHA® ring technology and neoprene bushings.

Product Specifications	
Product Type	Cord Connectors
Material/Style	Nylon Miniature
Cord Diameter Range	.15"-.21" (3.7-5.3)
Cord Connector Body Style	Straight Male
HUB Size	3/8"
Color	 Black
Effective Operating Temperature	-30°F to +225°F (-34°C to +107°C)
Recommended Knockout Hole Size	.67"-.68" (16.9-172)
Flammability	Hubbell nylon cord connectors have a UL 94-V2 rating.
Dimension A	.81" (20.6) Dia.
Dimension B	1.44" (36.6) Ref.
Dimension C	.41" (10.4)
Dimension D	.36" (9.1) Throat Dia.
Dimension E A/C	.81" (20.6)

Dimension E A/F	.75" (19.1)
Certifications	UL Listed, CSA Certified
Packaging	Bulk 25
M Drawings	Click here for M-Drawing
Catalog Page	Click here for catalog page T86
Catalog Section	Click here for Section-T
UPC Number	78358502293
Weight in LBs	0.5

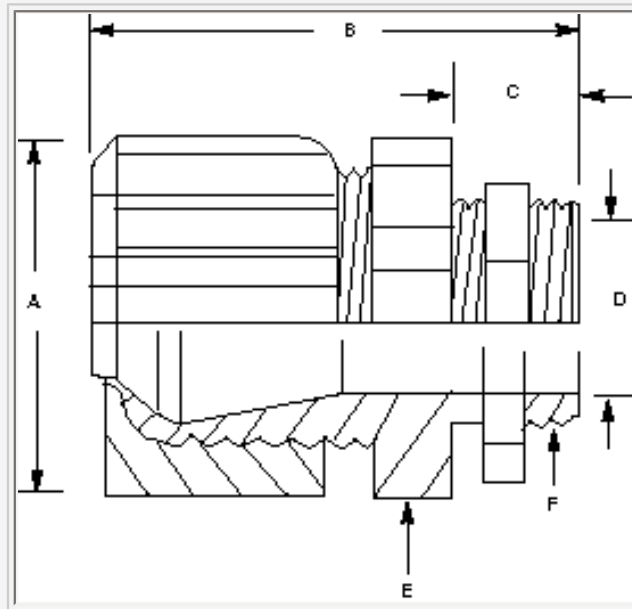

Miniature Nylon Cord Connectors HUBBELL JUNIORS®



Gray Cord Connector



Black Cord Connector



Gray Cord Connector with Spiral



Black Cord Connector with Spiral

Gray Snap-In
Cord ConnectorBlack Snap-In
Cord Connector

Miniature Nylon Cord Connector

N.P.T. Hub Size	Cord Dia. Range		Gray	Black
	Inches	(mm)		
1/4"	.08"-.14"	(1.9-3.4)	HJ1001GPK25	HJ1001BPK25
	.14"-.20"	(3.4-5.1)	HJ1002GPK25	HJ1002BPK25
	.20"-.27"	(5.1-6.7)	HJ1003GPK25	HJ1003BPK25
3/8"	.15"-.21"	(3.7-5.3)	HJ1004GPK25	HJ1004BPK25
	.21"-.28"	(5.3-7.0)	HJ1005GPK25	HJ1005BPK25
	.28"-.34"	(7.0-8.6)	HJ1006GPK25	HJ1006BPK25
1/2"	.06"-.13"	(1.6-3.2)	HJ1055GPK25	HJ1055BPK25
	.13"-.19"	(3.2-4.7)	HJ1056GPK25	HJ1056BPK25
	.19"-.25"	(4.7-6.3)	HJ1057GPK25	HJ1057BPK25
	.25"-.31"	(6.3-7.9)	HJ1058GPK25	HJ1058BPK25
	.31"-.38"	(7.9-9.5)	HJ1059GPK25	HJ1059BPK25
	.38"-.44"	(9.5-11.1)	HJ1060GPK25	HJ1060BPK25



Miniature Nylon Cord Connector with Spiral

N.P.T. Hub Size	Cord Dia. Range		Gray	Black
	Inches	(mm)		
1/4"	.08"-.14"	(1.9-3.4)	HJ1010GPK25	HJ1010BPK25
	.14"-.20"	(3.4-5.1)	HJ1011GPK25	HJ1011BPK25
	.20"-.27"	(5.1-6.7)	HJ1012GPK25	HJ1012BPK25
3/8"	.15"-.21"	(3.7-5.3)	HJ1013GPK25	HJ1013BPK25
	.21"-.28"	(5.3-7.0)	HJ1014GPK25	HJ1014BPK25
	.28"-.34"	(7.0-8.6)	HJ1015GPK25	HJ1015BPK25
1/2"	.13"-.19"	(3.2-4.7)	HJ1038GPK25	HJ1038BPK25
	.19"-.25"	(4.7-6.3)	HJ1039GPK25	HJ1039BPK25
	.25"-.31"	(6.3-7.9)	HJ1040GPK25	HJ1040BPK25
	.31"-.38"	(7.9-9.5)	HJ1041GPK25	HJ1041BPK25
	.38"-.44"	(9.5-11.1)	HJ1042GPK25	HJ1042BPK25
	3/4"	.25"-.49"	(6.4-12.3)	HJ1043GPK25
.45"-.71"		(11.4-18.0)	HJ1044GPK25	HJ1044BPK25



Miniature Nylon Snap-In Cord Connector with Spiral

Cord Diameter Range Inches (mm)	For Chassis Thickness	Gray	Black
.28"-.32" (7.1-8.1)	.10" (2.5) Max	HS1002GPK25	HS1002BPK25
.30"-.36" (7.6-9.1)	.13" (3.2) Max	HS1003GPK25	HS1003BPK25
.32"-.43" (8.1-10.9)	.13" (3.2) Max	HS1004GPK25	HS1004BPK25

Notes: Catalog numbers above with "PK25" suffix, i.e. HJ1001GPK25, are bulk packed 25 per carton.

See pages T-97 and T-98 for additional technical data and dimensional drawings.